

DeltaSol® E



rosenthal design 

The *DeltaSol® E* offers many possibilities for a broad range of solar and heating systems.

Due to its intelligent and easy-to-understand system configuration and its integrated calorimeter, the controller also offers the control of complex systems with up to 4 weather-compensated heating circuits.

Customised and OEM versions are available on request. Please contact our sales team.



System controller for up to 4 heating circuits!

- 10 sensor inputs and 7 relay outputs
- 7 basic systems to choose from
- Pump speed control, solar operating hours counter and heat quantity measurement
- Up to 4 weather-compensated heating circuits with HKM3 modules
- Extended manual mode with minimum and maximum speed
- 3 PWM/0-10V outputs for the speed control of high-efficiency pumps
- Standard PWM characteristic curves for solar and heating pumps
- Commissioning menu
- With reset, DHW heating and screed drying functions
- VBus® menu for configuring remote displays, e. g. SDFK

RESOL *DeltaSol® E*

Price bracket A | Article no.: **115 661 23**

RESOL *DeltaSol® E* – Full kit

Incl. 6 Pt1000 sensors (2 x FKP6, 4 x FRP6)

Price bracket A | Article no.: **115 661 33**

RESOL *DeltaSol® E* – SD3 Full kit

Incl. Smart Display SD3 and 6 Pt1000 sensors (2 x FKP6, 4 x FRP6)

Price bracket A | Article no.: **115 662 83**

Menu languages:



Basic systems

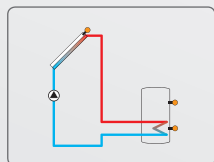

Solar system with 1 store

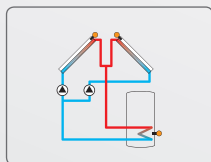

Solar system with east-/west collectors and 1 store, pump logic

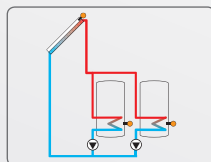

Solar system with 2 stores, pump logic

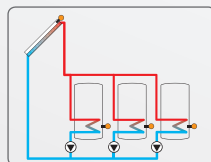

Solar system with 3 stores, pump logic

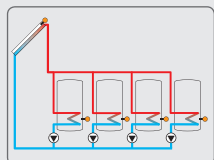

Solar system with 4 stores, pump logic

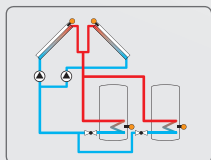

Solar system with east-/west collectors and 2 stores, pump-/ valve logic

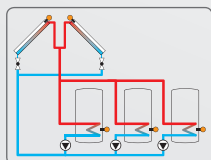

Solar system with east-/west collectors and 3 stores, valve-/pump logic

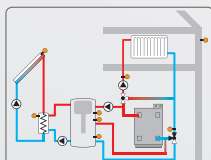

Solar system with combined store, external heat exchanger, weather-compensated heating circuit, return preheating and backup heating

Technical data

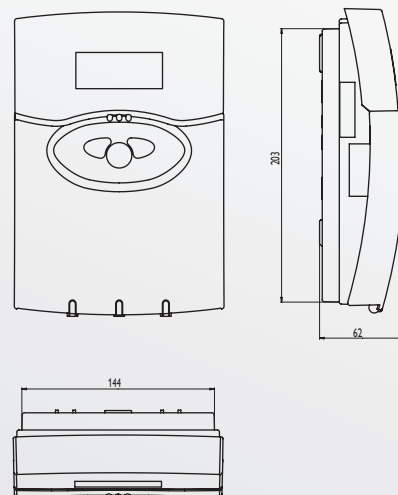

Electrical connection

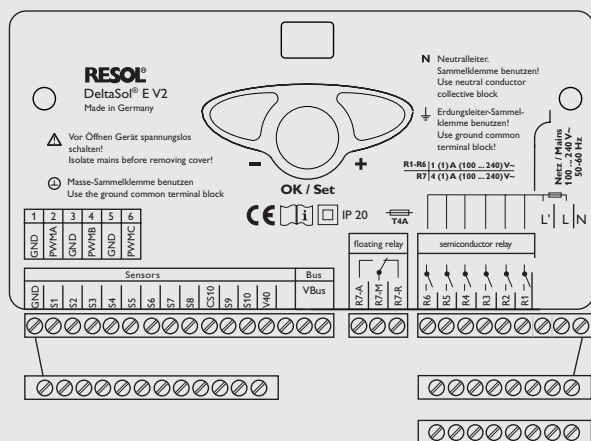

Inputs: 10 sensor inputs for Pt1000, CS10, V40

Outputs: 6 semiconductor relays, 3 of them for pump speed control, 1 potential-free relay and 3 PWM outputs (convertible to 0-10V signal outputs)

PWM frequency: 512 Hz

PWM voltage: 10.5 V

Switching capacity:

1 (1) A 240 V~ (semiconductor relay)
2 (1) A 24 V~/240 V~ (potential-free relay)

Total switching capacity: 4 A 240 V~

Power supply: 100 ... 240 V~ (50 ... 60 Hz)

Supply connection: type Y attachment

Standby: 0.98 W

Temperature controls class: III

Energy efficiency [%]: 1,5

Mode of operation: type 1.B.C.Y action

Rated impulse voltage: 2.5 kV

Data interface: RESOL VBus®

VBus® current supply: 35 mA

Functions: heating circuit backup, heat exchange control, thermostatic backup heating, solid fuel boiler, heat quantity measurement, collector cooling function, tube collector function, antifreeze function, minimum limitation, speed control, screed drying, function control

Housing: plastic, PC-ABS and PMMA

Mounting: wall mounting, mounting into patch panels is possible

Indication/Display: 4-line LC text display, illuminated, menu-driven (multilingual)

Operation: 3 push buttons at the front

Ingress protection: IP 20/EN 60529

Protection class: II

Ambient temperature: 0 ... 40 °C

Pollution degree: 2

Dimensions: 227 x 156 x 62 mm

Accessories

RESOL DL2 Datalogger



For visualisation via VBus.net, incl. SD card and network cable, mains adapter and VBus® cable pre-connected

Price bracket A | Article no.: **180 007 10** 304.00 €

RESOL HKM3



Heating circuit module for a weather-compensated heating circuit

Price bracket A | Article no.: **145 440 60**

RESOL SP10



Sensor overvoltage protection

Price bracket A | Article no.: **180 110 70**

RESOL AM1



Alarm module for signalling system failures

Price bracket B | Article no.: **180 008 70**

RESOL SDFK Smart Display



Display module with 3 displays for biomass boiler temperature and store temperature as well as for the pump status

Price bracket A | Article no.: **180 010 80**

RESOL SD3 Smart Display



Display module for the living area with 3 displays for collector and store temperature as well as for heat quantity

Price bracket A | Article no.: **180 004 90**