

DeltaSol® BS/4 – Quick facts

Differential temperature controller for solar and heating systems



C US

Possible systems

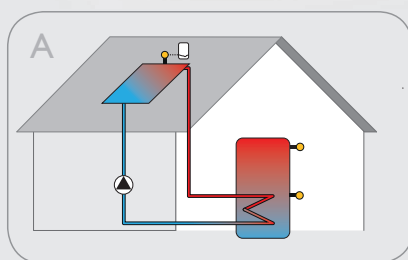

3 sensors, solar collector & solar tank

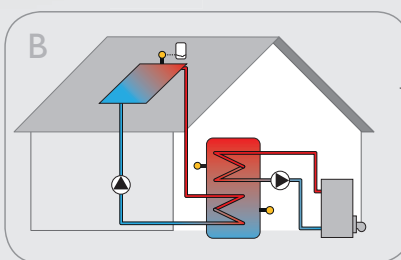

Solar collector & solar tank, gas booster

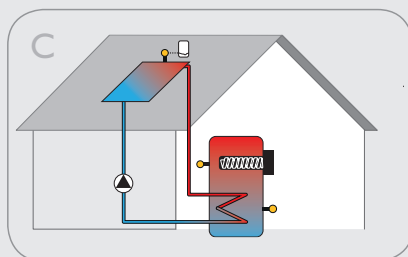

Solar collector & solar tank, electric booster (incl. auxiliary relay)

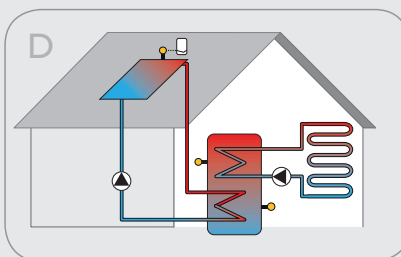

Solar collector & solar tank, hydronic floor system

Technical data

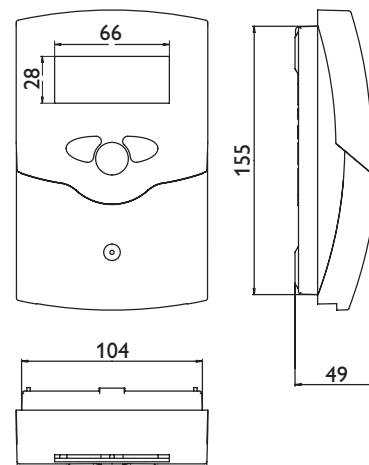

Electrical connection

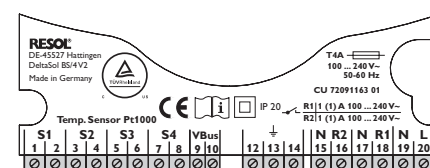

Inputs: 4 Pt1000 temperature sensors

Outputs: 2 semiconductor relays

Switching capacity:

1 (1) A 240V~ (semiconductor relay)

Total switching capacity: 2 A 240V~

Power supply: 100...240V~ (50...60 Hz)

Supply connection: type Y attachment

Power consumption: < 1 W (standby)

Mode of operation: type 1.C.Y action

Rated impulse voltage: 2.5 kV

Data interface: RESOL VBus®

VBus® current supply: 35 mA

Functions: functionality control, operating hours counter, evacuated tube collector function, energy metering, drainback function including booster function, heat dissipation function and pump speed control

Housing: plastic, PC-ABS and PMMA

Mounting: wall mounting, mounting into patch panels is possible

Indication/Display: System-Monitoring-Display for visualization of systems, 16-segment and 7-segment display, 8 symbols for indication of system status and operating control lamp

Operation: 3 push buttons at the front

Ingress protection: IP 20/EN 60529

Protection class: II

Ambient temperature: 0...40 °C/32...104 °F

Pollution degree: 2

Dimensions: 172 x 110 x 49 mm/6.77" x 4.33" x 1.92"

Exemplary figure for illustrating the connection possibilities

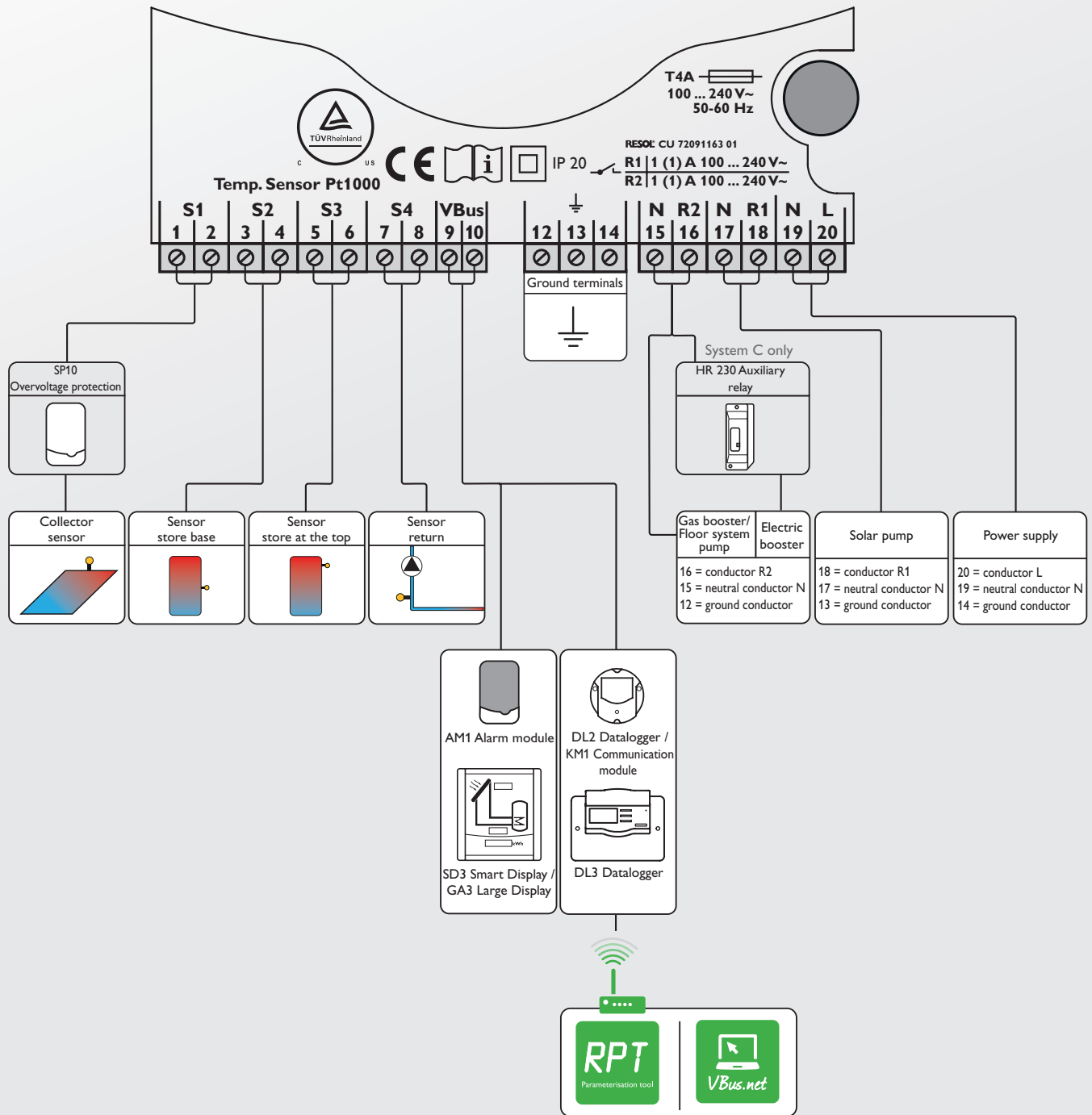

RESOL GA3
Large Display module with 3 displays for collector and tank temperatures as well as for heat quantity, incl. power supply



RESOL AM1
Alarm module for signaling system failures



RESOL SD3 Smart Display
Display module for the living area with 3 displays for collector and tank temperature as well as for heat quantity



RESOL SP10
Sensor overvoltage protection



RESOL DL2 Datalogger
Datalogger incl. RESOL Service CD, SD card and LAN cable, power supply adapter and VBus® cable pre-connected



RESOL HR230
Auxiliary relay



RESOL DL3 Datalogger
Datalogger incl. RESOL Service CD, SD card, power supply adapter, LAN and VBus® cable



RESOL Moisture-proof housing
Moisture-proof housing for controller installation outdoors or in highly humid locations (without controller)